

RECOMMENDED FFC/FPC DIMENSION

- HOUSING MATERIAL: HEAT RESISTANT PLASTIC UL94 V-0.
ACTUATOR MATERIAL: HEAT RESISTANT PLASTIC UL94 V-0.
- TERMINAL MATERIAL: PHOSPHOR BRONZE.
2-1. PLATED WITH BRIGHT TIN(100%) 80u"~150u"
2-2. PLATED WITH MATTE TIN(100%) 80u"~150u"
2-3. PLATED WITH GOLD MORE THAN 1u.
- FITTING NAIL MATERIAL: BRASS.
3-1. PLATED WITH BRIGHT TIN(100%) 80u"~150u"
3-2. PLATED WITH MATTE TIN(100%) 80u"~150u"
- PARTS NO: 10101X-XOXXXO

- 1: 雾锡
 - 2: 亮锡
 - 3: 镀金1u'
 - 5: 镀金3u'
 - 6: 半金锡
- 0: 正脚
 - 1: 反脚
- 1: 管装
 - 2: 卷装
 - 3: 袋装
 - 4: 其他

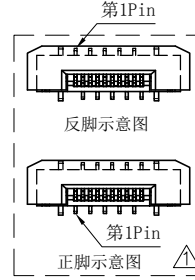

No. of contacts (n)	Dimensions				
	A	B	C	D	E
4	8.10	6.85	2.60	1.50	
5	8.60	7.35	3.10	2.00	
6	9.10	7.85	3.60	2.50	
7	9.60	8.35	4.10	3.00	0.14
8	10.10	8.85	4.60	3.50	
9	10.60	9.35	5.10	4.00	
10	11.10	9.85	5.60	4.50	
11	11.60	10.35	6.10	5.00	
12	12.10	10.85	6.60	5.50	
13	12.60	11.35	7.10	6.00	
14	13.10	11.85	7.60	6.50	
15	13.60	12.35	8.10	7.00	
16	14.10	12.85	8.60	7.50	
17	14.60	13.35	9.10	8.00	
18	15.10	13.85	9.60	8.50	
19	15.60	14.35	10.10	9.00	
20	16.10	14.85	10.60	9.50	
21	16.60	15.35	11.10	10.00	
22	17.10	15.85	11.60	10.50	
23	17.60	16.35	12.10	11.00	
24	18.10	16.85	12.60	11.50	0.15
25	18.60	17.35	13.10	12.00	
26	19.10	17.85	13.60	12.50	
27	19.60	18.35	14.10	13.00	
28	20.10	18.85	14.60	13.50	
29	20.60	19.35	15.10	14.00	
30	21.10	19.85	15.60	14.50	
31	21.60	20.35	16.10	15.00	
32	22.10	20.85	16.60	15.50	
33	22.60	21.35	17.10	16.00	
34	23.10	21.85	17.60	16.50	
35	23.60	22.35	18.10	17.00	
36	24.10	22.85	18.60	17.50	
37	24.60	23.35	19.10	18.00	
38	25.10	23.85	19.60	18.50	
39	25.60	24.35	20.10	19.00	
40	26.10	24.85	20.60	19.50	
41	26.60	25.35	21.10	20.00	
42	27.10	25.85	21.60	20.50	
43	27.60	26.35	22.10	21.00	
44	28.10	26.85	22.60	21.50	0.16
45	28.60	27.35	23.10	22.00	
46	29.10	27.85	23.60	22.50	
47	29.60	28.35	24.10	23.00	
48	30.10	28.85	24.60	23.50	
49	30.60	29.35	25.10	24.00	
50	31.10	29.85	25.60	24.50	

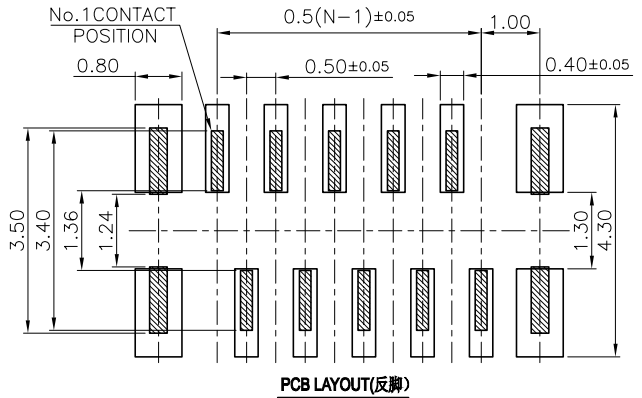
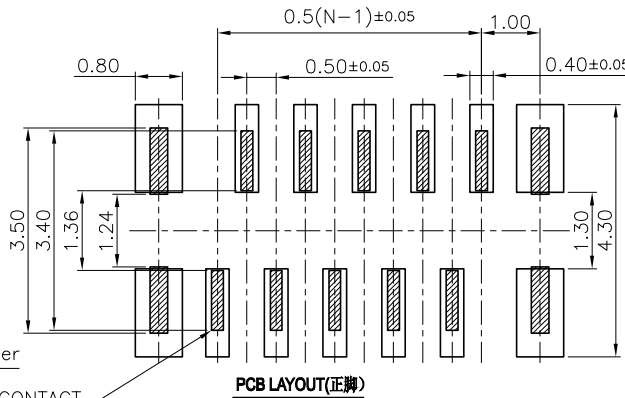
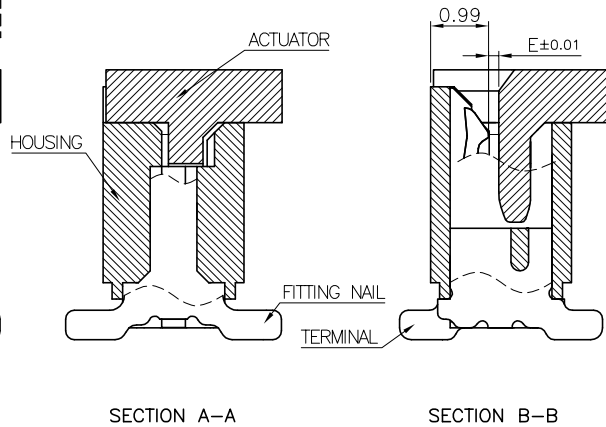
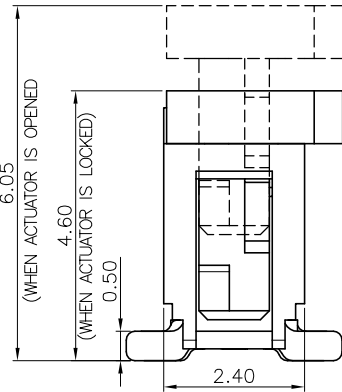

UNLESS OTHERWISE SPECIFIED TOLERANCES ARE			
X.			
X.X	±0.20		
X.XX	±0.10		
X.XXX			
ANG.	±0°30'		
增加正反脚标识	陈天舒	2014-05-26	UNIT
REVISIONS	CHK	DATE	MM

客户图		北极大电子科技有限公司		
Drawings		BEIJIDA ELECTRONICS TECHNOLOGY CO. LIMITED		
APPROVED	DATE	COMPUTER NO	10101X-XOXXXO	
CHECKED	DATE	NAME	FPC0.5-6代 H2.4立贴成品	
陈天舒	2012-05-23			
DRAWN	DATE	SIZE	SCALE	REV
张运兴	2012-05-23	A4	8:1	B

Pin数	A0	A1	B0	B1	K0	F	W	卷数量
4			8.60	5.00		10.25	24	
5			9.10	5.50		10.25	24	
6			9.60	6.00		10.25	24	
7			10.10	6.50		10.25	24	
8			10.60	7.00		10.25	24	
9			11.10	7.50		10.25	24	
10			11.60	8.00		10.25	24	
11			12.10	8.50		10.25	24	
12			12.60	9.00		10.25	24	
13			13.10	9.50		10.25	24	
14			13.60	10.00		10.25	24	
15			14.10	10.50		10.25	24	
16			14.60	11.00		10.25	24	
17			15.10	11.50		10.25	24	
18			15.60	12.00		10.25	24	
19			16.10	12.50		10.25	24	
20			16.60	13.00		10.25	24	
21			17.10	13.50		14.25	32	
22			17.60	14.00		14.25	32	
23			18.10	14.50		14.25	32	
24			18.60	15.00		14.25	32	
25			19.10	15.50		14.25	32	
26			19.60	16.00		20.25	44	
27	4.50	3.50	20.10	16.50	4.80	20.25	44	1000PCS /卷
28			20.60	17.00		20.25	44	
29			21.10	17.50		20.25	44	
30			21.60	18.00		20.25	44	
31			22.10	18.50		20.25	44	
32			22.60	19.00		20.25	44	
33			23.10	19.50		20.25	44	
34			23.60	20.00		20.25	44	
35			24.10	20.50		20.25	44	
36			24.60	21.00		20.25	44	
37			25.10	21.50		20.25	44	
38			25.60	22.00		20.25	44	
39			26.10	22.50		20.25	44	
40			26.60	23.00		20.25	44	
41			27.10	23.50		20.25	44	
42			27.60	24.00		20.25	44	
43			28.10	24.50		20.25	44	
44			28.60	25.00		20.25	44	
45			29.10	25.50		20.25	44	
46			29.60	26.00		20.25	44	
47			30.10	26.50		20.25	44	
48			30.60	27.00		20.25	44	
49			31.10	27.50		20.25	44	
50			31.60	28.00		20.25	44	

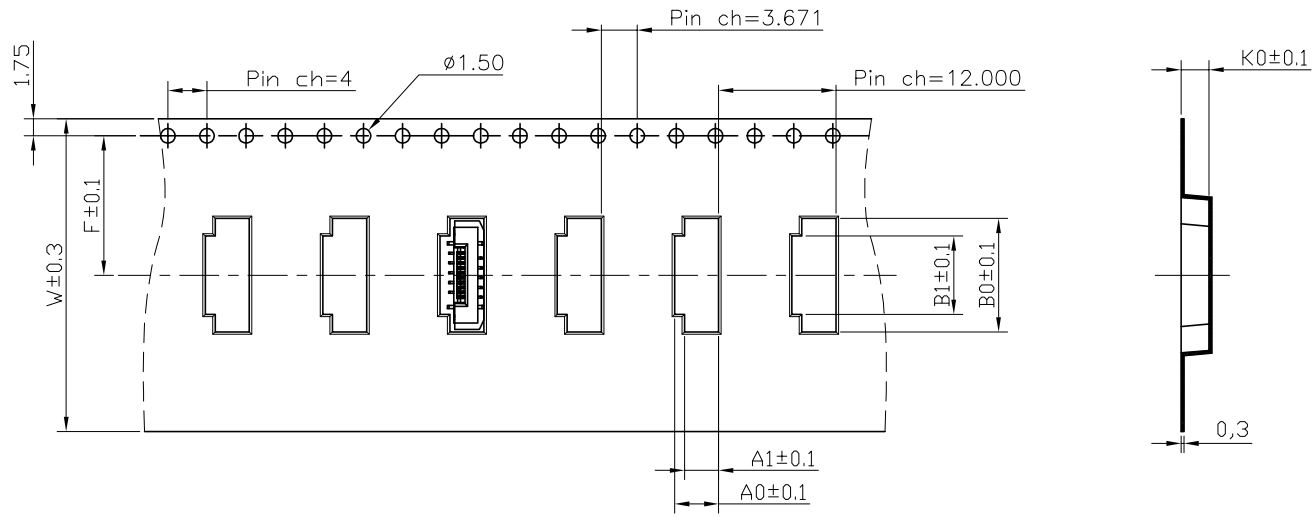

→ User Direction of Unreeling

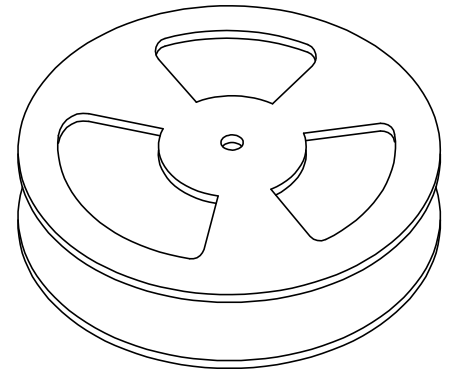

PARTS NO: 10101X-20XXX0

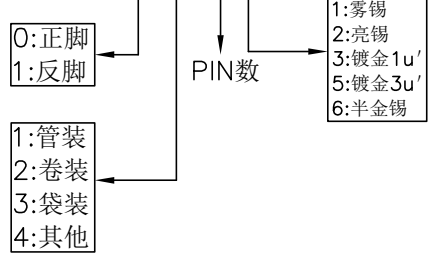

				UNLESS OTHERWISE SPECIFIED TOLERANCES ARE		包装图		北极大电子科技有限公司		
						Package Figure		BEIJIDA ELECTRONICS TECHNOLOGY CO. LIMITED		
						APPROVED		DATE		COMPUTER NO
								2011-10-11		10101X-20XXX0
						CHECKED		DATE		NAME
						陈天舒		2011-10-11		FPC0.5-6代 H2.4立贴卷装图
						DRAWN		DATE		SIZE
						张运兴		2011-10-11		A4
						UNIT		SCALE		REV
						MM		3:4		A
SER	REVISIONS	CHK	DATE							