

SECTION B-B

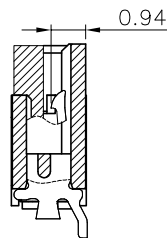

SECTION A-A
Bottom Contact Side

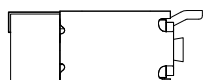
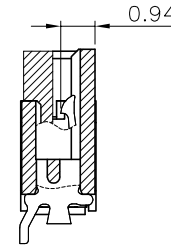

SECTION A-A
Upper Contact Side.

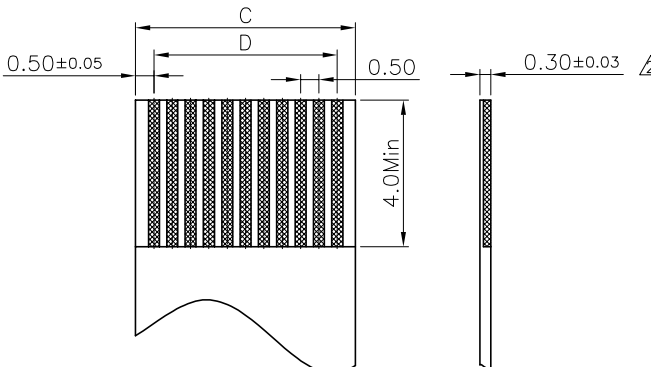

F.P.C DIMENSION(REF.)

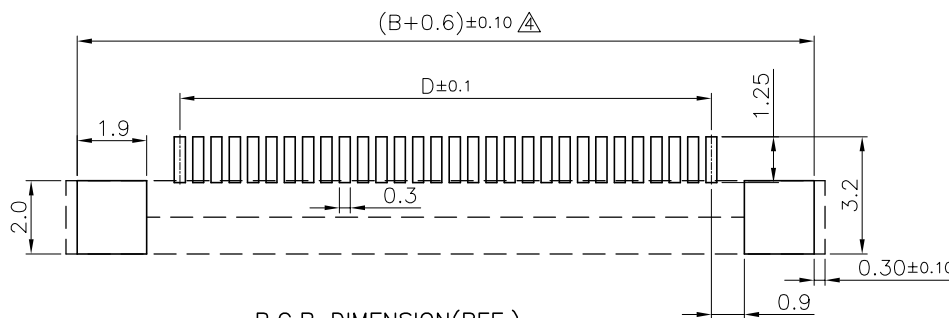

P.C.B DIMENSION(REF.)

P数	DIM=A	DIM=B	DIM=C	DIM=D
4	7.70	6.50	2.55	1.50
5	8.20	7.00	3.05	2.00
6	8.70	7.50	3.55	2.50
7	9.20	8.00	4.05	3.00
8	9.70	8.50	4.55	3.50
9	10.20	9.00	5.05	4.00
10	10.70	9.50	5.55	4.50
11	11.20	10.00	6.05	5.00
12	11.70	10.50	6.55	5.50
13	12.20	11.00	7.05	6.00
14	12.70	11.50	7.55	6.50
15	13.20	12.00	8.05	7.00
16	13.70	12.50	8.55	7.50
17	14.20	13.00	9.05	8.00
18	14.70	13.50	9.55	8.50
19	15.20	14.00	10.05	9.00
20	15.70	14.50	10.55	9.50
21	16.20	15.00	11.05	10.00
22	16.70	15.50	11.55	10.50
23	17.20	16.00	12.05	11.00
24	17.70	16.50	12.55	11.50
25	18.20	17.00	13.05	12.00
26	18.70	17.50	13.55	12.50
27	19.20	18.00	14.05	13.00
28	19.70	18.50	14.55	13.50
29	20.20	19.00	15.05	14.00
30	20.70	19.50	15.55	14.50
31	21.20	20.00	16.05	15.00
32	21.70	20.50	16.55	15.50
33	22.20	21.00	17.05	16.00
34	22.70	21.50	17.55	16.50
35	23.20	22.00	18.05	17.00
36	23.70	22.50	18.55	17.50
37	24.20	23.00	19.05	18.00
38	24.70	23.50	19.55	18.50
39	25.20	24.00	20.05	19.00
40	25.70	24.50	20.55	19.50
41	26.20	25.00	21.05	20.00
42	26.70	25.50	21.55	20.50
43	27.20	26.00	22.05	21.00
44	27.70	26.50	22.55	21.50
45	28.20	27.00	23.05	22.00
46	28.70	27.50	23.55	22.50
47	29.20	28.00	24.05	23.00
48	29.70	28.50	24.55	23.50
49	30.20	29.00	25.05	24.00
50	30.70	29.50	25.55	24.50

NOTES: △

- HOUSING MATERIAL: PA-6T HEAT RESISTANT PLASTIC UL94 V-0.
ACTUATOR MATERIAL: PPS HEAT RESISTANT PLASTIC UL94 V-0.
- TERMINAL MATERIAL: PHOSPHOR BRONZE C5210.
2-1.PLATED WITH BRIGHT TIN(100%) 80u' ~150u'
2-2.PLATED WITH MATTE TIN(100%) 80u' ~150u'
2-3.PLATED WITH GOLD MORE THAN 1u' OR 3u'
- FITTING NAIL MATERIAL: Phosphor Bronze C2680
3-1.PLATED WITH BRIGHT TIN(100%) 50u' ~90u'
3-2.PLATED WITH MATTE TIN(100%) 50u' ~90u'
- PARTS NO: 10100X-X0XXX0

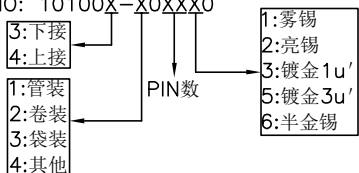

SER	REVISIONS	CHK	DATE	UNIT	MM
△	修正PCB推荐尺寸	张运兴	2016-05-31	X.X	±0.20
△	增加材料标示	陈天舒	2014-06-24	X.XX	±0.10
△	修改尺寸公差	张运兴	2014-02-27	X.XXX	ANG.
△	修改C项尺寸	陈天舒	2012-11-22	ANG.	±0°30'

客户图 Drawings		北极大电子科技有限公司 BEIJIDA ELECTRONICS TECHNOLOGY CO. LIMITED		
APPROVED	DATE	COMPUTER NO	10100X-X0XXX0	
CHECKED	DATE	NAME	FPC0.5-2代H2.0拉拔式成品	
DRAWN	DATE	SIZE	SCALE	REV
张运兴	2012-05-20	A4	8:1	E

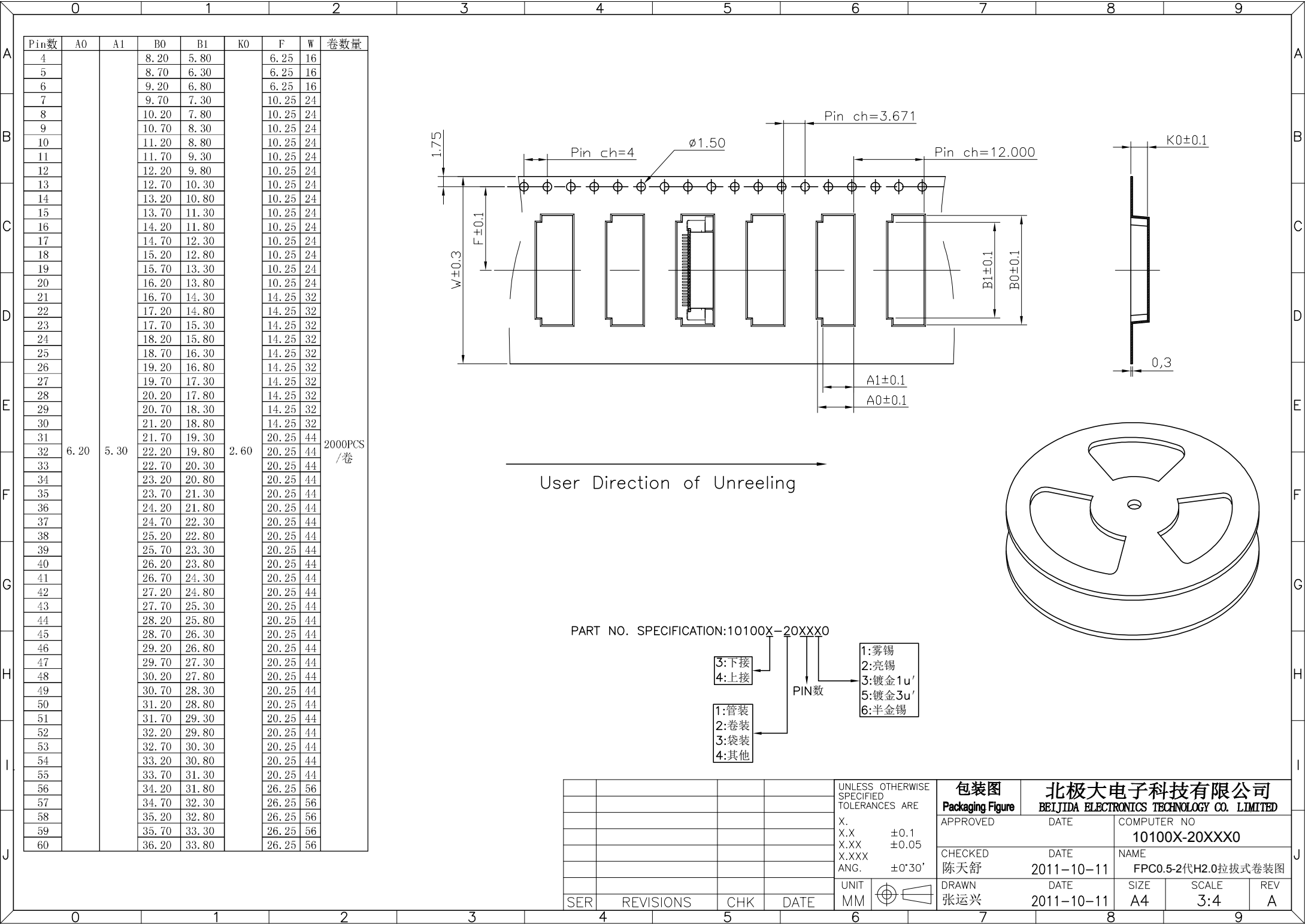

Pin数	A0	A1	B0	B1	K0	F	W	卷数量
4			8.20	5.80		6.25	16	
5			8.70	6.30		6.25	16	
6			9.20	6.80		6.25	16	
7			9.70	7.30		10.25	24	
8			10.20	7.80		10.25	24	
9			10.70	8.30		10.25	24	
10			11.20	8.80		10.25	24	
11			11.70	9.30		10.25	24	
12			12.20	9.80		10.25	24	
13			12.70	10.30		10.25	24	
14			13.20	10.80		10.25	24	
15			13.70	11.30		10.25	24	
16			14.20	11.80		10.25	24	
17			14.70	12.30		10.25	24	
18			15.20	12.80		10.25	24	
19			15.70	13.30		10.25	24	
20			16.20	13.80		10.25	24	
21			16.70	14.30		14.25	32	
22			17.20	14.80		14.25	32	
23			17.70	15.30		14.25	32	
24			18.20	15.80		14.25	32	
25			18.70	16.30		14.25	32	
26			19.20	16.80		14.25	32	
27			19.70	17.30		14.25	32	
28			20.20	17.80		14.25	32	
29			20.70	18.30		14.25	32	
30			21.20	18.80		14.25	32	
31	6.20	5.30	21.70	19.30	2.60	20.25	44	2000PCS /卷
32			22.20	19.80		20.25	44	
33			22.70	20.30		20.25	44	
34			23.20	20.80		20.25	44	
35			23.70	21.30		20.25	44	
36			24.20	21.80		20.25	44	
37			24.70	22.30		20.25	44	
38			25.20	22.80		20.25	44	
39			25.70	23.30		20.25	44	
40			26.20	23.80		20.25	44	
41			26.70	24.30		20.25	44	
42			27.20	24.80		20.25	44	
43			27.70	25.30		20.25	44	
44			28.20	25.80		20.25	44	
45			28.70	26.30		20.25	44	
46			29.20	26.80		20.25	44	
47			29.70	27.30		20.25	44	
48			30.20	27.80		20.25	44	
49			30.70	28.30		20.25	44	
50			31.20	28.80		20.25	44	
51			31.70	29.30		20.25	44	
52			32.20	29.80		20.25	44	
53			32.70	30.30		20.25	44	
54			33.20	30.80		20.25	44	
55			33.70	31.30		20.25	44	
56			34.20	31.80		26.25	56	
57			34.70	32.30		26.25	56	
58			35.20	32.80		26.25	56	
59			35.70	33.30		26.25	56	
60			36.20	33.80		26.25	56	

PART NO. SPECIFICATION: 10100X-20XXX0

- 1:管装
 - 2:卷装
 - 3:袋装
 - 4:其他
- 3:下接
 - 4:上接
- 1:雾锡
 - 2:亮锡
 - 3:镀金1u'
 - 5:镀金3u'
 - 6:半金锡

			UNLESS OTHERWISE SPECIFIED TOLERANCES ARE		包装图 Packaging Figure		北极大电子科技有限公司 BEIJIDA ELECTRONICS TECHNOLOGY CO. LIMITED		
			X. X.X ±0.1 X.XX ±0.05 X.XXX ANG. ±0°30'		APPROVED		DATE		COMPUTER NO
					CHECKED		DATE		NAME
					陈天舒		2011-10-11		FPC0.5-2代H2.0拉拔式卷装图
					DRAWN		DATE		SIZE
					张运兴		2011-10-11		SCALE
SER			REVISIONS		CHK		DATE		REV
									A